

Designer's™ Data Sheet
SWITCHMODE Series
NPN Silicon Power Transistors

These devices are designed for high-voltage, high-speed power switching inductive circuits where fall time is critical. They are particularly suited for 115 and 220 V SWITCHMODE applications such as Switching Regulators, Inverters, Motor Controls, Solenoid/Relay drivers and Deflection circuits.

SPECIFICATION FEATURES:

- Reverse Biased SOA with Inductive Loads @ $T_C = 100^\circ\text{C}$
- Inductive Switching Matrix 0.5 to 1.5 Amp, 25 and 100°C
... $t_C @ 1 \text{ A}, 100^\circ\text{C}$ is 290 ns (Typ).
- 700 V Blocking Capability
- SOA and Switching Applications Information.

MJE13002*
MJE13003*

*Motorola Preferred Device

1.5 AMPERE
NPN SILICON
POWER TRANSISTORS
300 AND 400 VOLTS
40 WATTS

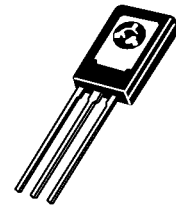

CASE 77-08
TO-225AA TYPE

MAXIMUM RATINGS

Rating	Symbol	MJE13002	MJE13003	Unit
Collector-Emitter Voltage	$V_{CEO(sus)}$	300	400	Vdc
Collector-Emitter Voltage	V_{CEV}	600	700	Vdc
Emitter Base Voltage	V_{EBO}	9		Vdc
Collector Current — Continuous	I_C	1.5		Adc
— Peak (1)	I_{CM}	3		
Base Current — Continuous	I_B	0.75		Adc
— Peak (1)	I_{BM}	1.5		
Emitter Current — Continuous	I_E	2.25		Adc
— Peak (1)	I_{EM}	4.5		
Total Power Dissipation @ $T_A = 25^\circ\text{C}$ Derate above 25°C	P_D	1.4		Watts
		11.2		mW/ $^\circ\text{C}$
Total Power Dissipation @ $T_C = 25^\circ\text{C}$ Derate above 25°C	P_D	40		Watts
		320		mW/ $^\circ\text{C}$
Operating and Storage Junction Temperature Range	T_J, T_{stg}	-65 to +150		$^\circ\text{C}$

THERMAL CHARACTERISTICS

Characteristic	Symbol	Max	Unit
Thermal Resistance, Junction to Case	$R_{\theta JC}$	3.12	$^\circ\text{C}/\text{W}$
Thermal Resistance, Junction to Ambient	$R_{\theta JA}$	89	$^\circ\text{C}/\text{W}$
Maximum Load Temperature for Soldering Purposes: 1/8 from Case for 5 Seconds	T_L	275	$^\circ\text{C}$

(1) Pulse Test: Pulse Width = 5 ms, Duty Cycle $\leq 10\%$.

Designer's Data for "Worst Case" Conditions — The Designer's Data Sheet permits the design of most circuits entirely from the information presented. SOA Limit curves — representing boundaries on device characteristics — are given to facilitate "worst case" design.

Preferred devices are Motorola recommended choices for future use and best overall value.

Designer's and SWITCHMODE are trademarks of Motorola, Inc.

REV 4



MJE13002 MJE13003

ELECTRICAL CHARACTERISTICS (T_C = 25°C unless otherwise noted)

Characteristic	Symbol	Min	Typ	Max	Unit
OFF CHARACTERISTICS (1)					
Collector–Emitter Sustaining Voltage (I _C = 10 mA, I _B = 0)	V _{CEO(sus)}	300 400	— —	— —	Vdc
Collector Cutoff Current (V _{CEV} = Rated Value, V _{BE(off)} = 1.5 Vdc) (V _{CEV} = Rated Value, V _{BE(off)} = 1.5 Vdc, T _C = 100°C)	I _{CEV}	— —	— —	1 5	mAdc
Emitter Cutoff Current (V _{EB} = 9 Vdc, I _C = 0)	I _{EBO}	—	—	1	mAdc

SECOND BREAKDOWN

Second Breakdown Collector Current with base forward biased	I _{S/b}	See Figure 11			
Clamped Inductive SOA with base reverse biased	RBSOA	See Figure 12			

ON CHARACTERISTICS (1)

DC Current Gain (I _C = 0.5 Adc, V _{CE} = 2 Vdc) (I _C = 1 Adc, V _{CE} = 2 Vdc)	h _{FE}	8 5	— —	40 25	—
Collector–Emitter Saturation Voltage (I _C = 0.5 Adc, I _B = 0.1 Adc) (I _C = 1 Adc, I _B = 0.25 Adc) (I _C = 1.5 Adc, I _B = 0.5 Adc) (I _C = 1 Adc, I _B = 0.25 Adc, T _C = 100°C)	V _{CE(sat)}	— — — —	— — — —	0.5 1 3 1	Vdc
Base–Emitter Saturation Voltage (I _C = 0.5 Adc, I _B = 0.1 Adc) (I _C = 1 Adc, I _B = 0.25 Adc) (I _C = 1 Adc, I _B = 0.25 Adc, T _C = 100°C)	V _{BE(sat)}	— — —	— — —	1 1.2 1.1	Vdc

DYNAMIC CHARACTERISTICS

Current–Gain — Bandwidth Product (I _C = 100 mAdc, V _{CE} = 10 Vdc, f = 1 MHz)	f _T	4	10	—	MHz
Output Capacitance (V _{CB} = 10 Vdc, I _E = 0, f = 0.1 MHz)	C _{ob}	—	21	—	pF

SWITCHING CHARACTERISTICS

Resistive Load (Table 1)						
Delay Time	(V _{CC} = 125 Vdc, I _C = 1 A, I _{B1} = I _{B2} = 0.2 A, t _p = 25 μs, Duty Cycle ≤ 1%)	t _d	—	0.05	0.1	μs
Rise Time		t _r	—	0.5	1	μs
Storage Time		t _s	—	2	4	μs
Fall Time		t _f	—	0.4	0.7	μs
Inductive Load, Clamped (Table 1, Figure 13)						
Storage Time	(I _C = 1 A, V _{clamp} = 300 Vdc, I _{B1} = 0.2 A, V _{BE(off)} = 5 Vdc, T _C = 100°C)	t _{sv}	—	1.7	4	μs
Crossover Time		t _c	—	0.29	0.75	μs
Fall Time		t _{fi}	—	0.15	—	μs

(1) Pulse Test: PW = 300 μs, Duty Cycle ≤ 2%.

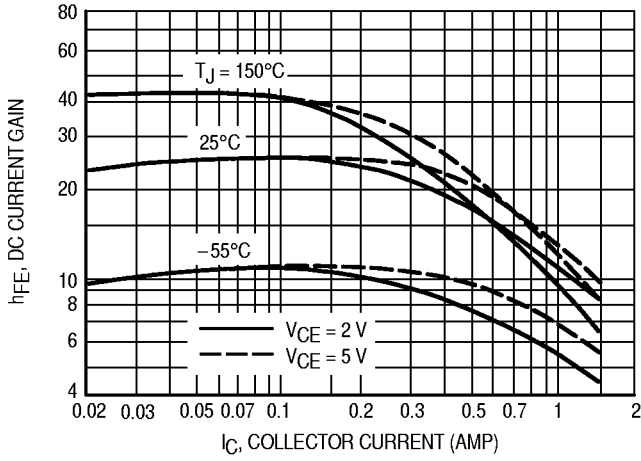

Figure 1. DC Current Gain

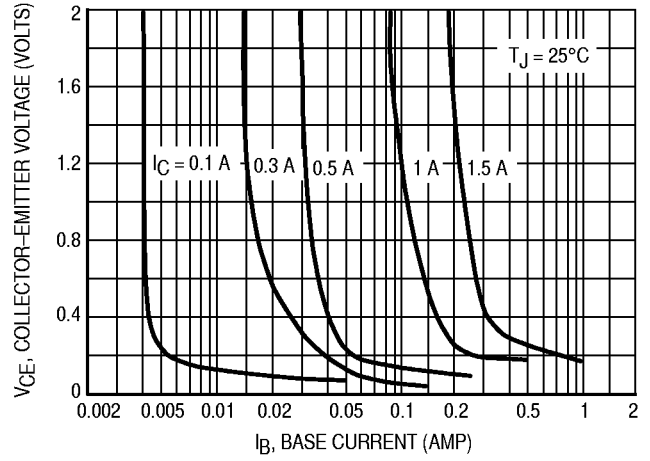

Figure 2. Collector Saturation Region

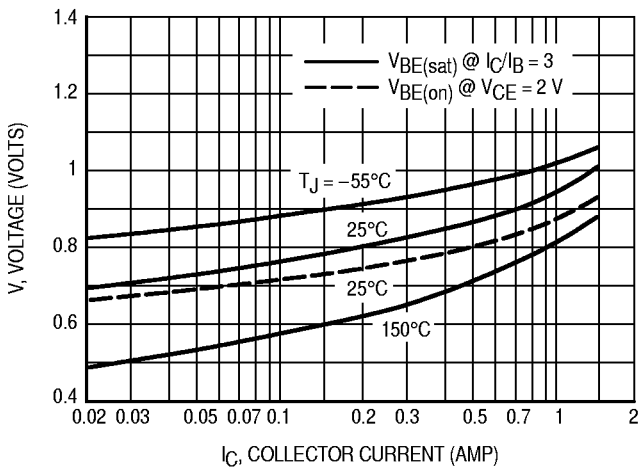

Figure 3. Base-Emitter Voltage

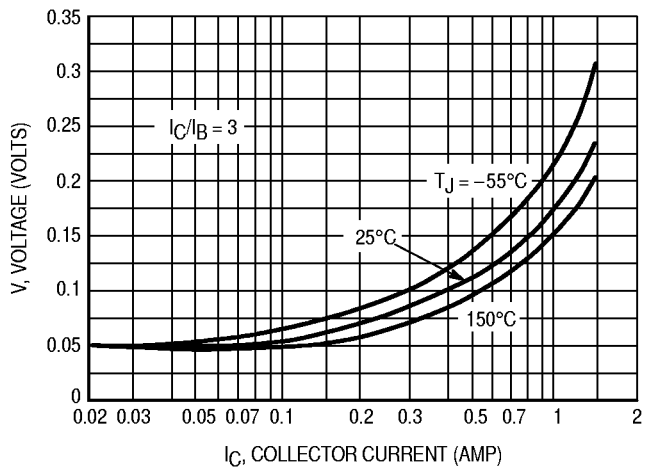

Figure 4. Collector-Emitter Saturation Region

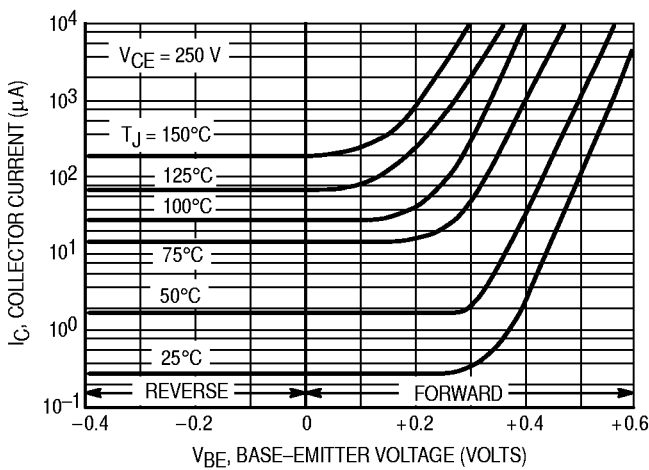

Figure 5. Collector Cutoff Region

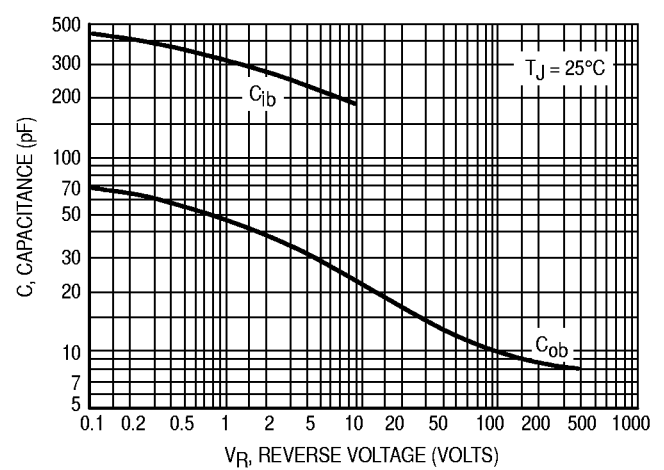

Figure 6. Capacitance

Table 1. Test Conditions for Dynamic Performance

REVERSE BIAS SAFE OPERATING AREA AND INDUCTIVE SWITCHING		RESISTIVE SWITCHING
TEST CIRCUITS	<p>DUTY CYCLE $\leq 10\%$ $t_r, t_f \leq 10$ ns</p> <p>NOTE PW and V_{CC} Adjusted for Desired I_C R_B Adjusted for Desired I_{B1}</p>	<p>+125 V R_C SCOPE TUT R_B D1 -4.0 V</p>
CIRCUIT VALUES	<p>Coil Data: Ferroxcube Core #6656 Full Bobbin (~200 Turns) #20</p> <p>GAP for 30 mH/2 A L_{coil} = 50 mH</p> <p>V_{CC} = 20 V V_{clamp} = 300 Vdc</p>	<p>V_{CC} = 125 V R_C = 125 Ω D1 = 1N5820 or Equiv. R_B = 47 Ω</p>
TEST WAVEFORMS	<p>OUTPUT WAVEFORMS</p> <p>t_1 Adjusted to Obtain I_C</p> $t_1 \approx \frac{L_{coil} (I_{Cpk})}{V_{CC}}$ $t_2 \approx \frac{L_{coil} (I_{Cpk})}{V_{clamp}}$ <p>Test Equipment Scope—Tektronics 475 or Equivalent</p>	<p>+10.3 V 25 μs 0 -8.5 V</p> <p>$t_r, t_f < 10$ ns Duty Cycle = 1.0% R_B and R_C adjusted for desired I_B and I_C</p>

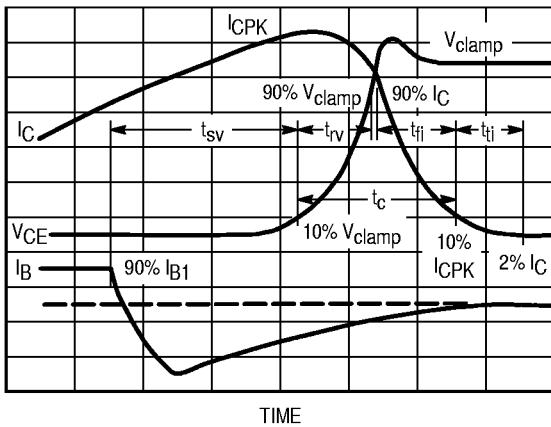

Figure 7. Inductive Switching Measurements

Table 2. Typical Inductive Switching Performance

I _C AMP	T _C °C	t _{sv} μs	t _{rv} μs	t _{fj} μs	t _{tj} μs	t _c μs
0.5	25	1.3	0.23	0.30	0.35	0.30
	100	1.6	0.26	0.30	0.40	0.36
1	25	1.5	0.10	0.14	0.05	0.16
	100	1.7	0.13	0.26	0.06	0.29
1.5	25	1.8	0.07	0.10	0.05	0.16
	100	3	0.08	0.22	0.08	0.28

NOTE: All Data Recorded in the Inductive Switching Circuit in Table 1

SWITCHING TIMES NOTE

In resistive switching circuits, rise, fall, and storage times have been defined and apply to both current and voltage waveforms since they are in phase. However, for inductive loads which are common to SWITCHMODE power supplies and hammer drivers, current and voltage waveforms are not in phase. Therefore, separate measurements must be made on each waveform to determine the total switching time. For this reason, the following new terms have been defined.

- t_{SV} = Voltage Storage Time, 90% I_{B1} to 10% V_{clamp}
- t_{rV} = Voltage Rise Time, 10–90% V_{clamp}
- t_{fi} = Current Fall Time, 90–10% I_C
- t_{ti} = Current Tail, 10–2% I_C
- t_c = Crossover Time, 10% V_{clamp} to 10% I_C

An enlarged portion of the inductive switching waveforms is

shown in Figure 7 to aid in the visual identity of these terms.

For the designer, there is minimal switching loss during storage time and the predominant switching power losses occur during the crossover interval and can be obtained using the standard equation from AN-222:

$$P_{SWT} = 1/2 V_{CC} I_C (t_c) f$$

In general, $t_{rV} + t_{fi} \approx t_c$. However, at lower test currents this relationship may not be valid.

As is common with most switching transistors, resistive switching is specified at 25°C and has become a benchmark for designers. However, for designers of high frequency converter circuits, the user oriented specifications which make this a "SWITCHMODE" transistor are the inductive switching speeds (t_c and t_{SV}) which are guaranteed at 100°C.

RESISTIVE SWITCHING PERFORMANCE

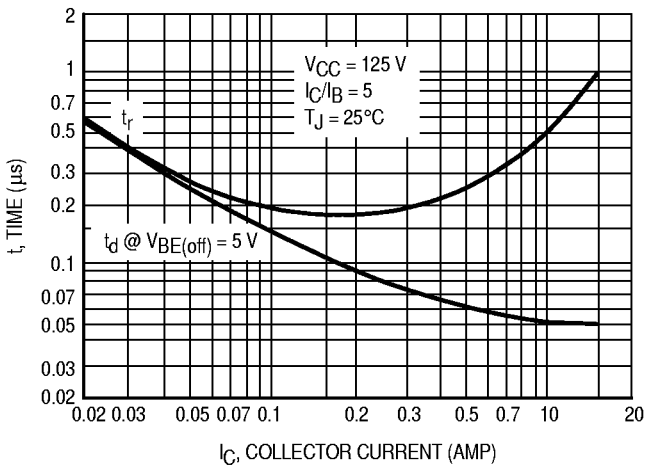

Figure 8. Turn-On Time

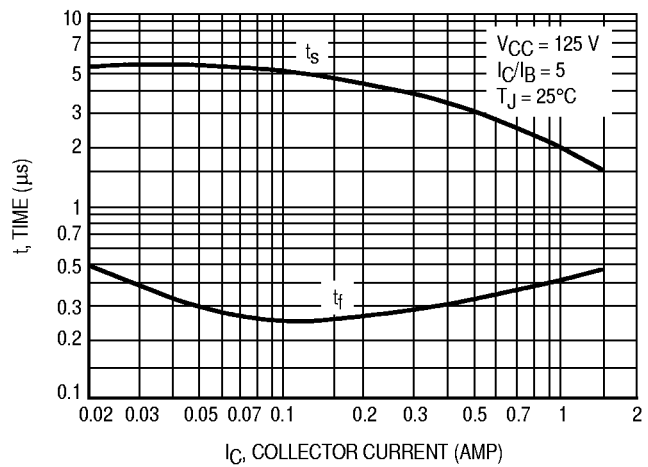

Figure 9. Turn-Off Time

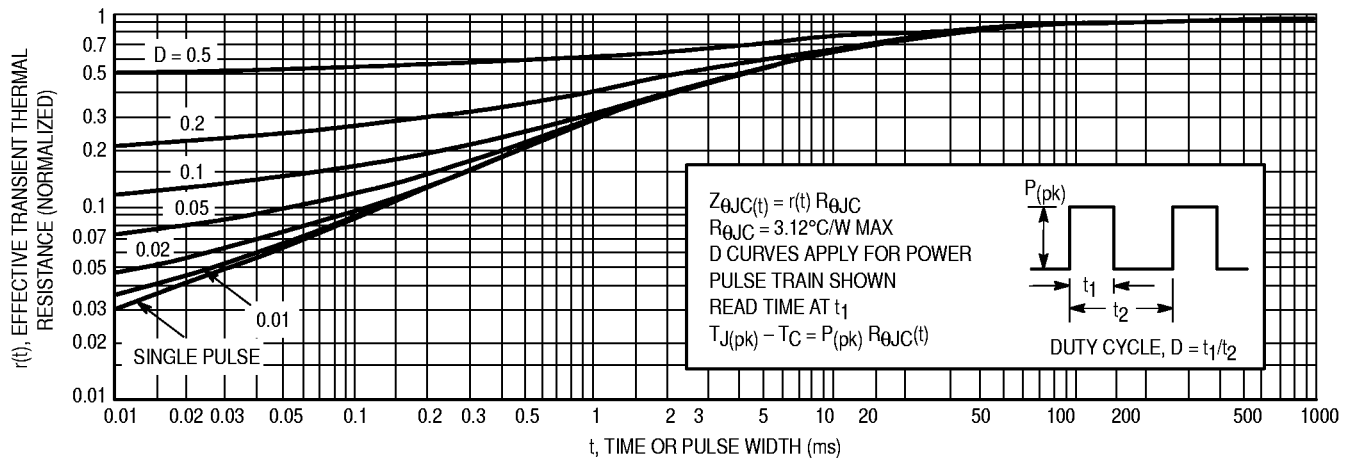

Figure 10. Thermal Response

MJE13002 MJE13003

The Safe Operating Area figures shown in Figures 11 and 12 are specified ratings for these devices under the test conditions shown.

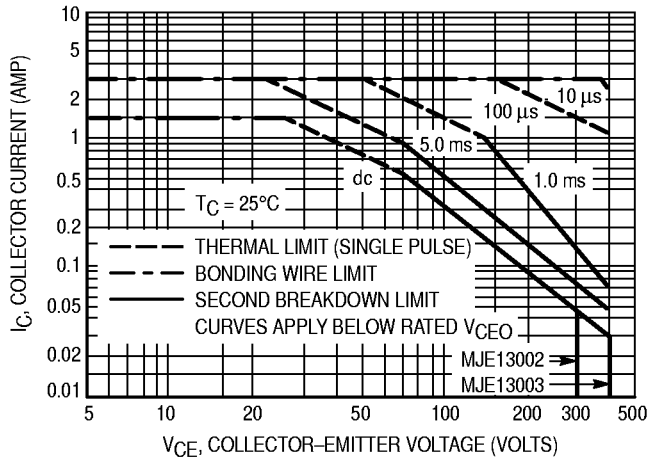

Figure 11. Active Region Safe Operating Area

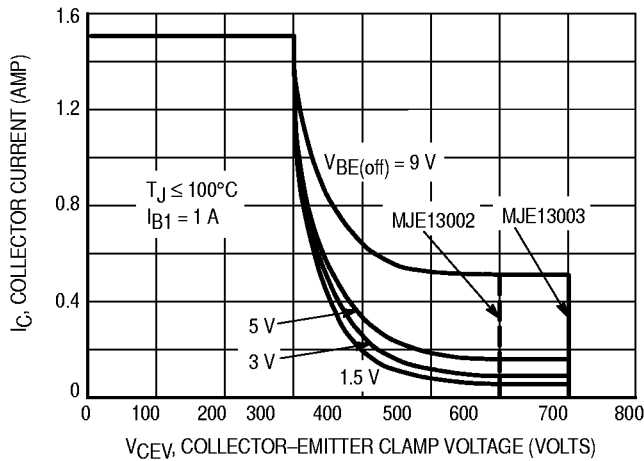

Figure 12. Reverse Bias Safe Operating Area

SAFE OPERATING AREA INFORMATION

FORWARD BIAS

There are two limitations on the power handling ability of a transistor: average junction temperature and second breakdown. Safe operating area curves indicate $I_C - V_{CE}$ limits of the transistor that must be observed for reliable operation; i.e., the transistor must not be subjected to greater dissipation than the curves indicate.

The data of Figure 11 is based on $T_C = 25^\circ\text{C}$; $T_J(\text{pk})$ is variable depending on power level. Second breakdown pulse limits are valid for duty cycles to 10% but must be derated when $T_C \geq 25^\circ\text{C}$. Second breakdown limitations do not derate the same as thermal limitations. Allowable current at the voltages shown on Figure 11 may be found at any case temperature by using the appropriate curve on Figure 13.

$T_J(\text{pk})$ may be calculated from the data in Figure 10. At high case temperatures, thermal limitations will reduce the power that can be handled to values less than the limitations imposed by second breakdown.

REVERSE BIAS

For inductive loads, high voltage and high current must be sustained simultaneously during turn-off, in most cases, with the base to emitter junction reverse biased. Under these conditions the collector voltage must be held to a safe level at or below a specific value of collector current. This can be accomplished by several means such as active clamping, RC snubbing, load line shaping, etc. The safe level for these devices is specified as Reverse Bias Safe Operating Area and represents the voltage-current conditions during reverse biased turn-off. This rating is verified under clamped conditions so that the device is never subjected to an avalanche mode. Figure 12 gives RBSOA characteristics.

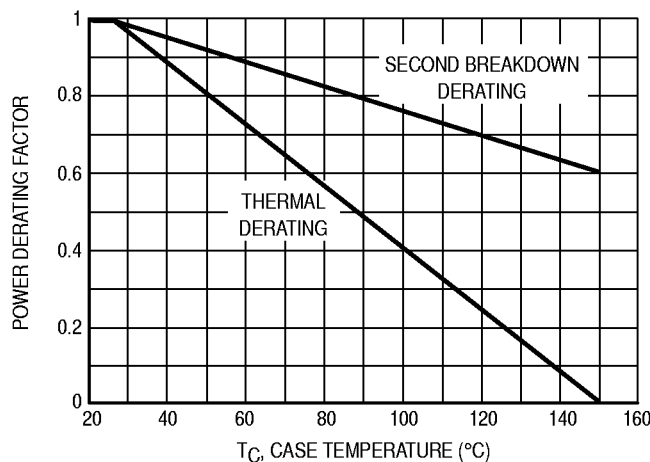
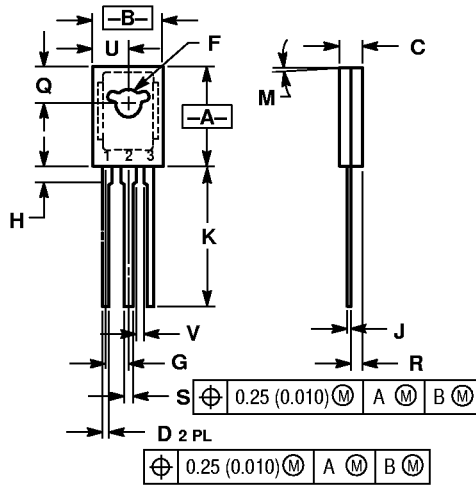

Figure 13. Forward Bias Power Derating

PACKAGE DIMENSIONS



- NOTES:
1. DIMENSIONING AND TOLERANCING PER ANSI Y14.5M, 1982.
 2. CONTROLLING DIMENSION: INCH.

DIM	INCHES		MILLIMETERS	
	MIN	MAX	MIN	MAX
A	0.425	0.435	10.80	11.04
B	0.295	0.305	7.50	7.74
C	0.095	0.105	2.42	2.66
D	0.020	0.026	0.51	0.66
F	0.115	0.130	2.93	3.30
G	0.094 BSC		2.39 BSC	
H	0.050	0.095	1.27	2.41
J	0.015	0.025	0.39	0.63
K	0.575	0.655	14.61	16.63
M	5° TYP		5° TYP	
Q	0.148	0.158	3.76	4.01
R	0.045	0.055	1.15	1.39
S	0.025	0.035	0.64	0.88
U	0.145	0.155	3.69	3.93
V	0.040	—	1.02	—

- STYLE 3:
1. BASE
 2. COLLECTOR
 3. EMITTER

CASE 77-08
TO-225AA TYPE
ISSUE V